

## 2.4 Components and functions out of scope of upgrading

In this section, solutions to alternate components and functions (\*1) which are out of scope of upgrading for CENTUM CS, CENTUM CS 1000/3000, and CENTUM VP.

\*1: Upgrading of PFC□ is included in the descriptions of CENTUM CS, CENTUM CS 1000/3000, and CENTUM VP.

### 2.4.1 System overall

#### ■ Upgrading of RIO system from CENTUM CS

The table below shows software packages and functions that are out of scope of the RIO System Upgrade.

**Table Software packages and functions out of scope of RIO System Upgrade**

Software package or function	Alternative solution
For power plant application: <ul style="list-style-type: none"> <li>• SIE1100 Standard operation and monitoring function for power plant</li> <li>• SHW5112 Builder for power plant</li> <li>• SF□8640 Process alarm function for power plant</li> <li>• SF□8650 Faceplate block function for power plant</li> <li>• SF□8660 SEQ-TBL software license for power plant</li> <li>• SF□8670 Logic chart software license for power plant</li> <li>• SCE1210 Communication gateway function for power plant</li> </ul>	Applications using HMI and FCS standard functions.
BRAIN communication (AAM11B Current/voltage input module (supports BRAIN); SIH5610 Sensor parameter definition package; and SF□2610 Sensor parameter communication package)	FieldMate
Hand Auto Station (HAS) connection	VP6H1150 Remote operation and monitoring package (HIS-TSE), etc.
Plant name	Applicable when a tag name consists of 14 alpha-numeric letters or less. Need change in tag names when a tag name has more than 14 alpha-numeric letters.
EI integration system (connecting with Yasukawa Electric Corp.'s products) <ul style="list-style-type: none"> <li>• CP builder (SHW5122, SIH5122, and SIU5122)</li> <li>• CP communication package (SIH2810, SIU2810)</li> <li>• Operation sequence support package (SIH4210, SIU4210)</li> <li>• Test package for operation sequence (SHW5123, SIH5123, SIU512)</li> </ul>	Upgrade with hardware and software from Yasukawa Electric Corp.
Applications for advanced control station (ACS)	Supported by advanced control (engineering), etc. <ul style="list-style-type: none"> <li>• Off-site ACS JOBCON is supported by OIL Movement Suite-VP JOBCON (a software package developed by Yokogawa Solution Service Corp. (YJP)).</li> </ul>

#### ■ Upgrading of RIO system from CENTUM CS 1000/CS 3000 and CENTUM VP

The table below shows software packages and functions that are out of scope of the RIO System Upgrade.

**Table Software packages and functions out of scope of RIO System Upgrade**

Software package or function	Alternative solution
BRAIN communication, AAM11B Current/voltage input module (supports BRAIN), and Sensor parameter definition package (Tokuchu)	FieldMate

## 2.4.2 For HMI Upgrade

### ■ Upgrading of RIO system from CENTUM CS

The table below shows software packages for HMI (operation & monitoring and engineering functions) which are out of scope of RIO System Upgrade.

#### ● For Operation and monitoring functions

**Table Software packages out of scope of RIO System Upgrade**

Model code	Description	Alternative solution
SIH120□	Multilingual package for ICS	Contact Yokogawa for languages other than English and Japanese.
SHW509□	Multilingual package for HP9000/700	
SIH2110	Ethernet communication driver	Windows standard function
SIH2120	RS-232C communication driver (TTY-Protocol)	Windows standard function
SIH2410	Remote server package for DDE	VP6H2411 Exaopc OPC interface package (for HIS) or NTPF100 Exaopc OPC interface package
SIH4120	Graphic 4 time size panel display package	Large monitor/panel
SIH4130	ITV window display package	Third-party product
SIH4131	ITV window control package	Third-party product
SIH4170	Voice output package	Windows application
SIH4180	Computer window package	Windows application (server/client)
SIH6500	Data acquisition package for ICS	Replace with the following functions: · VP6H6510 long-term data archive package · VP6H6530 report package · NTPP001 Exaquantum plant information management system
SIH6510	Long-term trend display package	
SIH6520	SQC package for ICS	
SIH6530	Logging package for ICs	
SHW6661	CS batch recipe management interface	Tokuchu software
SIH6663	CS batch production information management interface	NTPF100 Exaopc OPC interface package

#### ● For Engineering functions

**Table Software packages out of scope of RIO System Upgrade**

Model code	Description	Alternative solution
SIH5498	CS Database package	Third-party software or NTPP001 Exaquantum plant information management system
SIH5610	Sensor parameter definition package	Defining sensor parameters by FieldMate
SIH6310	Fuzzy-logic control package	Advanced control (engineering)
SIH6330	PREDICTROL package	Advanced control (engineering)
SIH5021	C language execution control package	Tokuchu software
SHW5030	C language development environment package	Tokuchu software

## ■ Upgrading of RIO system from CENTUM CS 1000/CS 3000

The table below shows software packages for HMI (operation & monitoring and engineering functions) which are out of scope of RIO System Upgrade.

### ● For Operation and monitoring functions

Table Software packages out of scope of RIO System Upgrade

for CS 1000	for CS 3000	Description	Alternative solution
Model code			
PHS2410	LHS2410	Open data interface package for DDE	VP6H2411 Exaopc OPC interface package (for HIS) for NTPF100 Exaopc OPC interface package
—	LHS4130	ITV window package	
PHS7110	LHS7110	Web monitoring package	VP6H1150 server for remote operation and monitoring function

### ● For Engineering functions

No package is out of scope of RIO System Upgrade. (All packages are subject to upgrading.)

## ■ Upgrading of RIO system from CENTUM VP

For upgrading HMI functions (operation and monitoring and engineering functions), no package is out of scope of RIO System Upgrade. (All packages are subject to upgrading.)

## 2.4.3 For FCS Upgrade

## ■ Upgrading of RIO system from CENTUM CS

The tables below shows software packages which are out of scope of RIO System Upgrade.

Table Software packages for FCS out of scope of RIO System Upgrade

Model code	Description	Alternative solution
SF□2610	Sensor parameter communication package	FieldMate
SF□3310	Fuzzy-logic control package	Advanced control (engineering)
SF□3330	PREDICTROL package	Advanced control (engineering)
SFH8630	SAMA block package	Tokuchu software

Table Subsystem communication software packages out of scope of RIO System Upgrade

Model code	Description	Alternative solution
SFH9063	ACM11 Siemens communication function package	Tokuchu software
SFH9078	ACM12 Siemens communication function package	Tokuchu software

**Table I/O modules out of scope of RIO System Upgrade**

I/O module related functions out of scope of RIO System Upgrade	Alternative solution
SP1 (Special linearization table)	Supported by control applications: Use the following function blocks. (*1) (*2) (*3) (*4) · FUNC-VAR · ZCTEMP Tokuchu function blocks
SQRT (Square-root process)	Supported by control applications: Use the input signal conversion of function blocks to perform SQRT (square root) calculation. (*4)
NON (Linearization of mV input module)	Supported by control applications: When the following input modules are used in the FCS with those linearization is specified as NON (through mode), use control application to convert them to 0-100%.  Applicable modules are: · AMM11T/AMM12T Voltage input multiplexer module · AMM42T Current input module · AMM21M/AMM22M mV input module
Auxiliary voltage output (*5) of analog input modules (AAM10, AAM11, AAM11B, AAM21, and AAM21J) and auxiliary output (*6) of pulse input module (APM11)	Supported by control applications: This module receives and calculates contact pulse, voltage pulse and current pulse from fields. It also carries out signal conversion of input signals to isolated transistor contact pulses, and outputs these as an auxiliary output.

- \*1: Use ZCTEMP to convert for either of the followings:  
- Number of conversion table is 16 points or more  
- The quadratic interpolation is specified.
- \*2: Alternating RTD input with SP1, specify the process output of the I/O module as RD and then select "RTD input (ohm)" for signal conversion in the IOM builder so that the resistance value (unit ohm) of the RTD can be obtained. Convert this value to a temperature by inputting it into FUNC-VAR or ZCTEMP.
- \*3: When alternating SP1 function with the function block, the input range must be set at the default.
- \*4: When alternating SQRT and SP1 functions with function blocks, the upper and lower limits of IOP detection differ. As for RIO, the IOP is detected by the value after converted by SQRT or SP1. As for I/O modules for RIO System Upgrade, IOP is detected by the value before conversion.
- \*5: The auxiliary voltage output is 1 - 5 V DC signal output from a CN1 connector of AMN11 nest to be used by recorders and analog I/O modules.
- \*6: The auxiliary output used for pulse input modules is converted to a transistor contact pulse with input signals isolated.

**Table Other functions out of scope of RIO System Upgrade**

FCS related functions out of scope of RIO System Upgrade	Alternative solution
IDCOM-Y	Advanced control (engineering)
Multiple area support	Combine multiple areas into one by engineering (performed by Yokogawa with fee).

## ■ Upgrading of RIO system from CENTUM CS 1000/CS 3000 and CENTUM VP

The tables below show software packages and functions related to FCS, which are out of scope of RIO System Upgrade.

**Table Software packages for FCS out of scope of RIO System Upgrade**

for CS 1000	for CS 3000/ VP	Description	Alternative solution
Model code			
PFS9063	LFS9063	SYSMAC communication package (for ACM11, ACM12)	Tokuchu software
PFS9055	LFS9055	Siemens communication package (for ACM11, ACM12)	Tokuchu software
PFS2211	LFS2211	DARWIN communication package (for ACM11)	Tokuchu software

**Table I/O module functions out of scope of RIO System Upgrade  
(Common for CENTUM CS 1000/CS 3000 and CENTUM VP)**

I/O module related functions out of scope of RIO System Upgrade	Alternative solution
SP1 (Special linearization table)	Supported by control applications: Use the following function blocks. (*1) (*2) (*3) (*4) · FUNC-VAR · ZCTEMP Tokuchu function blocks
SQRT (Square-root process)	Supported by control applications: Use the input signal conversion of function blocks to perform SQRT (square root) calculation. (*4)
Duplexed contact output module when both status and pulse-width output are in PFCS/SFCS	Define contact output module independently for status output and for pulse-width output. (*5)
Specifying pulse-width output of PFCS/SFCS contact output module to even-number channels	Pulse-width output is used starting from odd-number channel in output modules for RIO system upgrade. Even-number channels are assigned from even-number channels, which require change in wiring for field signal wirings.
Auxiliary voltage output (*6) of analog input modules (AAM10, AAM11, AAM11B, AAM21, and AAM21J) and auxiliary output (*7) of pulse input module (APM11)	Supported by control applications: This module receives and calculates contact pulse, voltage pulse and current pulse from fields. It also carries out signal conversion of input signals to isolated transistor contact pulses, and outputs them as auxiliary output.

- \*1: Use ZCTEMP to convert for either of the followings:  
- Number of conversion table is 16 points or more  
- The quadratic interpolation is specified.
- \*2: Alternating RTD input with SP1, specify the process output of the I/O module as RD and then select "RTD input (ohm)" for signal conversion in the IOM builder so that the resistance value (unit ohm) of the RTD can be obtained. Convert this value to a temperature by inputting it into FUNC-VAR or ZCTEMP.
- \*3: When alternating SP1 function with the function block, the input range must be set at the default.
- \*4: When alternating SQRT and SP1 functions with function blocks, the upper and lower limits of IOP detection differ. As for RIO, the IOP is detected by the value after converted by SQRT or SP1. As for I/O modules for RIO System Upgrade, IOP is detected by the value before conversion.
- \*5: Duplexed configuration cannot be selected for contact output module when both the status and the pulse-width output are used at the same time.
- \*6: The auxiliary voltage output is 1 - 5 V DC signal output from a CN1 connector of AMN11 nest to be used by recorders and analog I/O modules.
- \*7: The auxiliary output used for pulse input modules is converted to a transistor contact pulse with input signals isolated.

# 3. RIO system upgrade procedure

## 3.1 Upgrade procedure

The following diagram shows a typical upgrade procedure of the RIO system. The procedure and tasks may vary by existence of life cycle maintenance agreement, and method of upgrading and inspection.

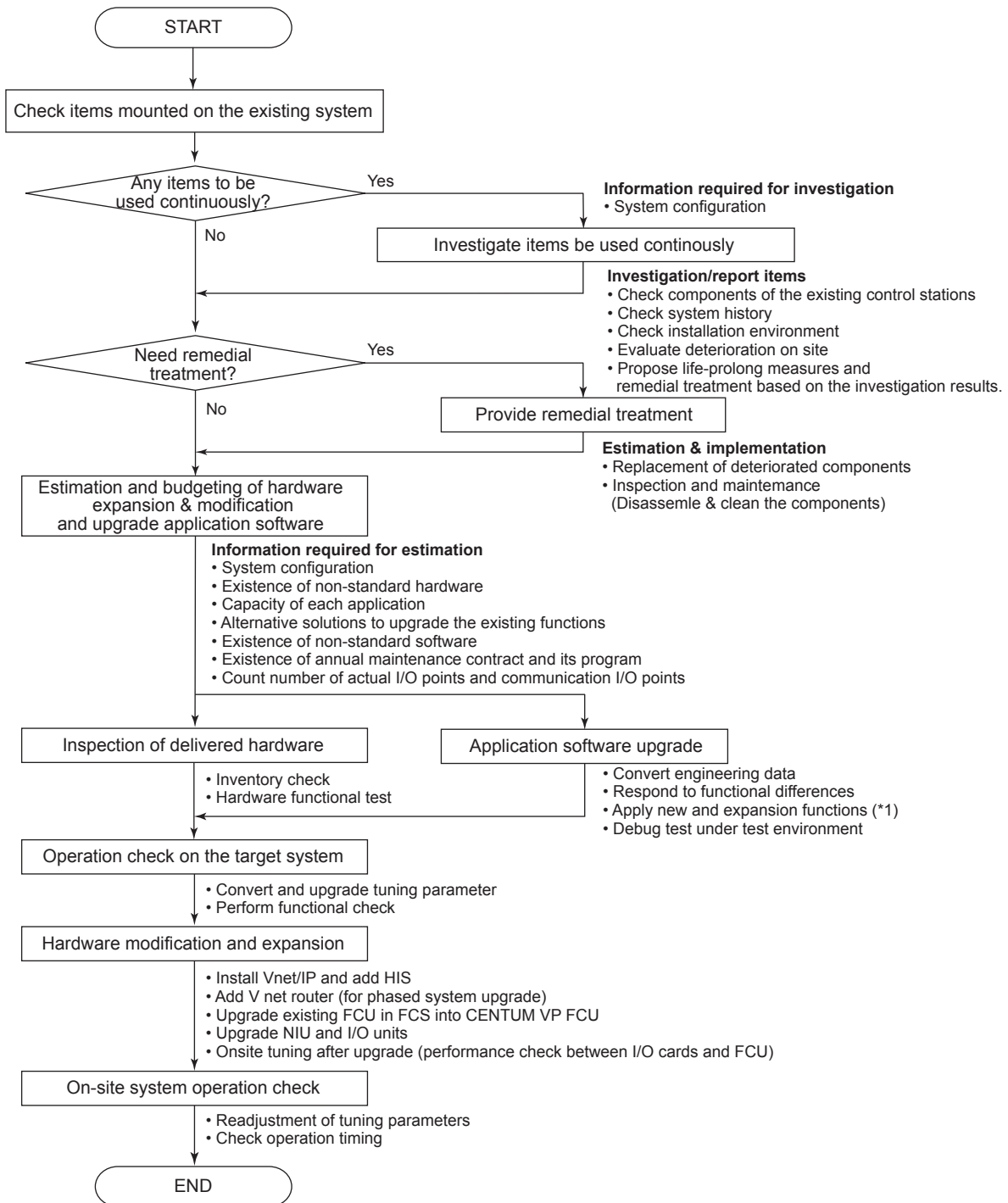

\*1: In case new or expanded functions exist at the same time at the system upgrade.

**Figure Upgrade Procedure**

---

## 3.2 Confirmation of Existing System Configuration

Prior to implement the RIO System Upgrade, confirm what components are mounted in the existing system.

- **Purpose of checking the existing system**

Check the existing system to find out what components are mounted so that items required for RIO System Upgrade can be determined. In case rack-mount type of modules are adopted, confirm the existence of the cabinets, and determine if new (additional) or modification of cabinets are required for upgrading or not.

---

### **IMPORTANT**

Especially, in case of proposing PFC□ to upgrade, empty space in up/bottom of the cabinet is required to install A2FV70□ FCU. In case such empty space is not available, addition of a cabinet has to be considered.

---

- **Check the existing system configuration**

The actual system configuration must be conducted against the manufacturing specifications (for hardware and application software) and outputs of self-documents. The items to be confirmed are as shown below:

**<System overall>**

- Investigation of power supply systems
- Installation of network control buses
- UPS (for the entire systems)
- Counting the number of actual I/O points and communication I/O points
- Others

**<For HMI>**

- HMI (console, desktop), external contact I/O (push button input, annunciator output)
- HMI (console, desktop), sound input/output terminal/sound definition information
- UPS (for HMI)
- External monitor output (for large screen output)
- Peripherals (message output printer, color hard copy unit, back-up equipment)
- Others

**<for FCS and cabinets>**

- Special auxiliary output
- Cold-junction compensation input
- Shunt resistor mounting
- Relay contact
- Others

### 3.3 Check healthiness of instruments to be used continuously

In case some of the existing instruments are used continuously after the system upgrade, check the healthiness of those instruments. The check items may vary by the time-based degrading and the maintenance status.

#### ● Purpose of checking

Those existing instruments can be used safely after upgrading the system depending on the healthiness of them. During this pre-assessment, following items are inspected at each control room where those instruments are installed. The results of the investigation will be reported along with the suggestions for remedial treatment and improvements.

#### ● Workflow

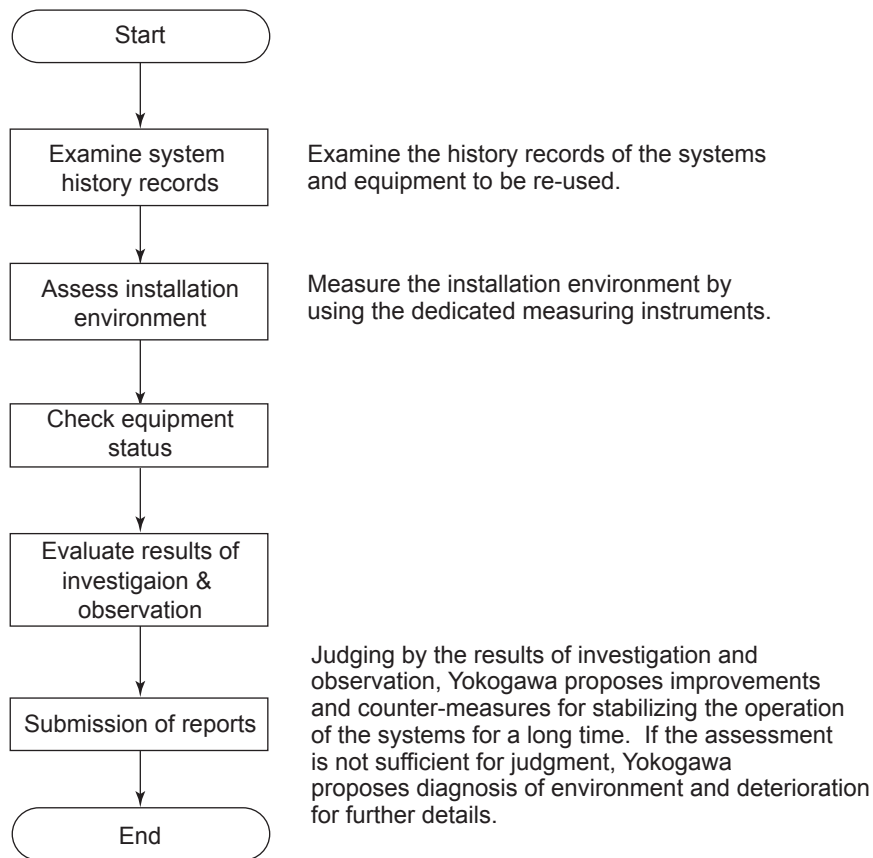

Figure Workflow



- **Menu for examining system history records**

- Occurrence of unconformity caused by the installation environment
- Time to replace spare parts with limited life
- Occurrence of unconformity incidents caused by deterioration

- **Assessment menu for installation environment**

Temperature, humidity, volume of floating dust, and density of corrosive gas (H<sub>2</sub>S, SO<sub>2</sub>, and Cl<sub>2</sub>)

- **Check menu for equipment status**

- Inside and outside of cabinets (filters, dusts on fans, corrosion on terminal screws, etc.)
- Dusts on the surface of I/O cards
- Patterns of printed circuit boards (exfoliation, corrosion, etc.)
- Soldering (creeping)
- Surface of components and parts (corrosion on IC read parts)
- Contacts (connectors' gold-plating, pitting by corrosion)
- Inspectors' stamps (condensation)
- Coating of I/O cards and CPU cards (\*1) (discoloring, cracking).

Note: Wiring for power supplies (power distribution), signal wiring (between field and I/O signals) are not included in the check menu for equipment status.

\*1: For the I/O cards with coating treatment only.

- **Reporting**

In order to continuously use the existing equipment with stability for long years, Yokogawa suggests necessary improvements and countermeasures.

**Table Check menu, countermeasures and remedial treatments**

Check menu	Countermeasures and remedial treatments	
<ul style="list-style-type: none"> <li>• Failures and incidents occurred in the plant through operation history</li> <li>• Temperature, humidity, dusts, corrosive gas</li> <li>• Daily operation environment by interviews</li> <li>• Years of operation for spare parts with limited lifespan</li> </ul>	Inspection and maintenance	I/O cards and units are dismantled and cleaned. Functional inspections are performed to confirm the healthiness of the I/O cards and units.
	Replacement of deteriorated components and parts	Spare parts with limited lifespan described in the instruction manuals (IM) (*1) and other spare parts that deteriorate in 10 years or longer are replaced. (*2)
	Partial replacement	In case failures are frequented or deteriorations are severe, and replacement by the part is difficult, the entire unit, card, or cable is replaced.

\*1: Spare parts with limited lifespan mean fans, condensers, fuses, filters, and relays.

\*2: The table on the next page shows the equipment and components that are to be used continuously and where those are used.

**Table** Equipment, components, and parts to be re-used

<b>Product names</b>	<b>Locations (except for products with limited lifespan)</b>	<b>Countermeasures and remedial treatments</b>
Signal conditioner cards	Fuse, variable resistors, aluminum electrolytic capacitors, photo couplers	Deteriorated modules and cards are replaced (overhauled)
Signal conditioner nests	Connectors, printed circuit boards (PCBs)	Replacement by the unit
Terminal boards, terminal blocks, relay boards	Aluminum electrolysis capacitors, connectors, PCBs	Replacement of deteriorated parts or by the unit
KS cables	Connectors	Replacement of cables
Power supply cables	Connectors	Replacement of cables

## 3.4 Activities for Improvements

Based on the feasibility study of the existing system, Yokogawa proposes an upgrading plan, discusses with customers in details, and take actions for improvements with customers' approval.

The activities for improvements require separate estimation and are implemented with onerous contract.

# 4. Upgrading hardware

## 4.1 Upgrading HMI hardware

- **Upgrading hardware for operation and monitoring**

The following figures show how to upgrade operation and monitoring functions. Install the latest software packages of operation and monitoring functions to an off-the-shelf PC and connect an operation keyboard to upgrade it to the CENTUM VP R6 HIS.

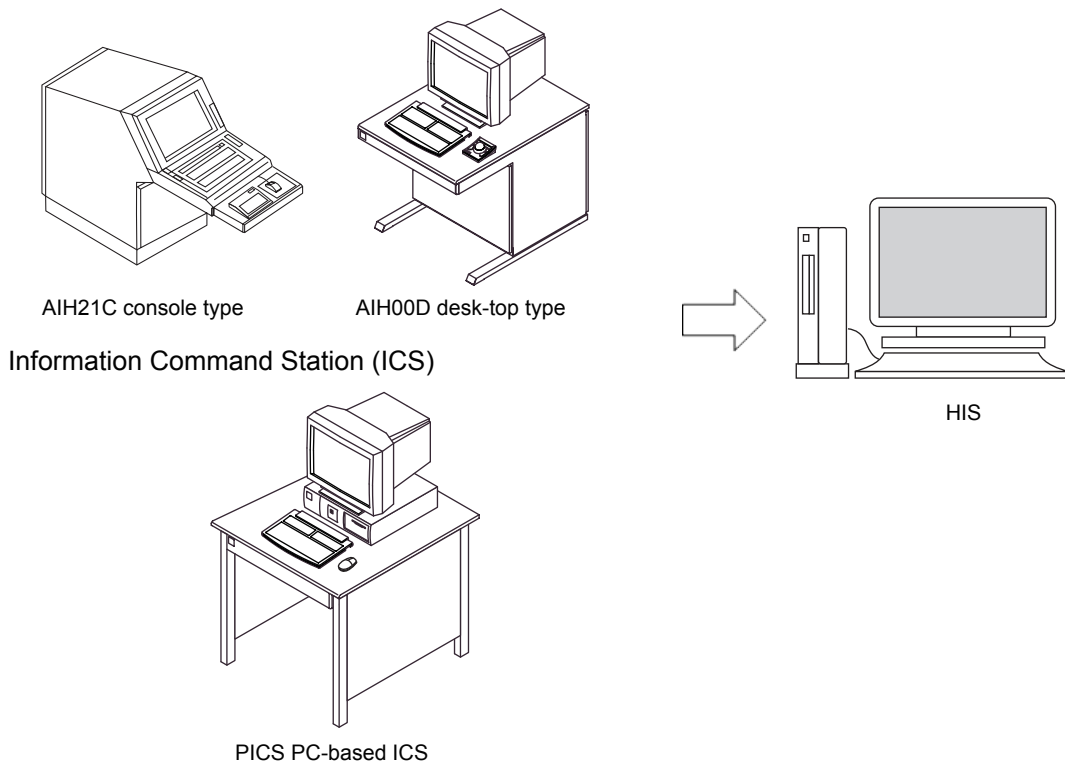

F040101.ai

HIS: Human interface station with AIP83□ operation keyboard

- **Upgrading the Engineering Hardware**

Upgrading the hardware for engineering functions is to replace old types of engineering stations with a new PC installed with the latest software packages of CENTUM VP R6 ENG (AD Suite) as shown below.

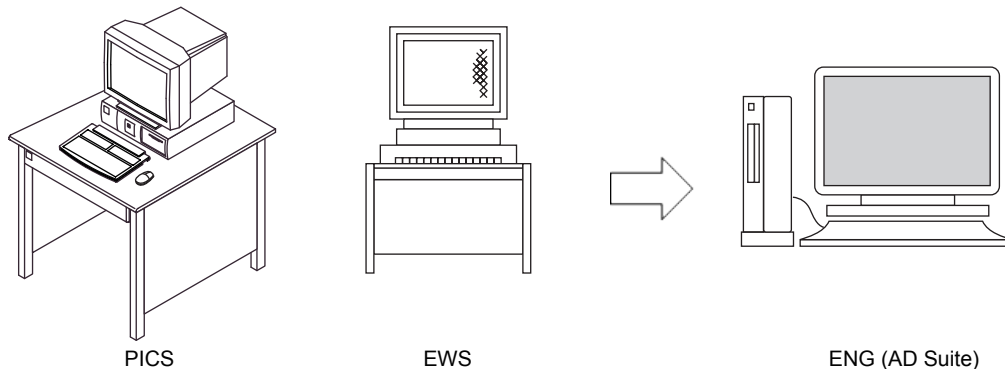

F040102.ai

## 4.2 Upgrading hardware of Field control stations

By using Field control units (FCU), Node interface units (NIO) and I/O cards exclusively developed for upgrading the RIO systems, the existing field control stations (FCS) for RIO system are upgraded.

### 4.2.1 Upgrading FCU

- Upgrading rack-mountable type FCU

Existing FCU		FCU after upgrading	
Model	Description	Model	Description
AFE10S	Field control unit (19-inch rack mountable type, main memory 8 MB, for V net/RIO)	A2FV70S	Field control unit (for RIO System Upgrade, 19-inch rack mountable)
AFM10S	Field control unit (19-inch rack mountable type, for V net/RIO)		
AFH10S	Field control unit (19-inch rack mountable type, capacity expanded type, for V net/RIO)		
AFS10S	Field control unit (19-inch rack mountable type, capacity enhanced type, for V net/RIO)		
AFG10S	Field control unit (19-inch rack mountable type, for V net/RIO,)		
AFE10D	Duplexed field control unit (19-inch rack mountable type, main memory 8 MB, for V net/RIO)	A2FV70D	Duplexed field control unit (for RIO System Upgrade, 19-inch rack mountable)
AFM10D	Duplexed field control unit (19-inch rack mountable type, for V net/RIO)		
AFH10D	Duplexed field control unit (19-inch rack mountable type, for V net/RIO)		
AFS10D	Duplexed field control unit (19-inch rack mountable, function expanded type, for V net/RIO)		
AFG10D	Duplexed field control unit (for 19-inch rack mountable type, for V net/RIO)		

- Upgrade items

The figure below shows an image how the existing rack mountable type FCU is upgraded into A2FV70□ Rack mountable FCU for RIO System Upgrade.

**SEE ALSO**

For the details of the A2FV70□ FCU, after upgrading, refer to the General Specifications (GS), "Field control unit, Cabinet utility kit (for RIO System Upgrade)" (GS 33J64E10-01EN).

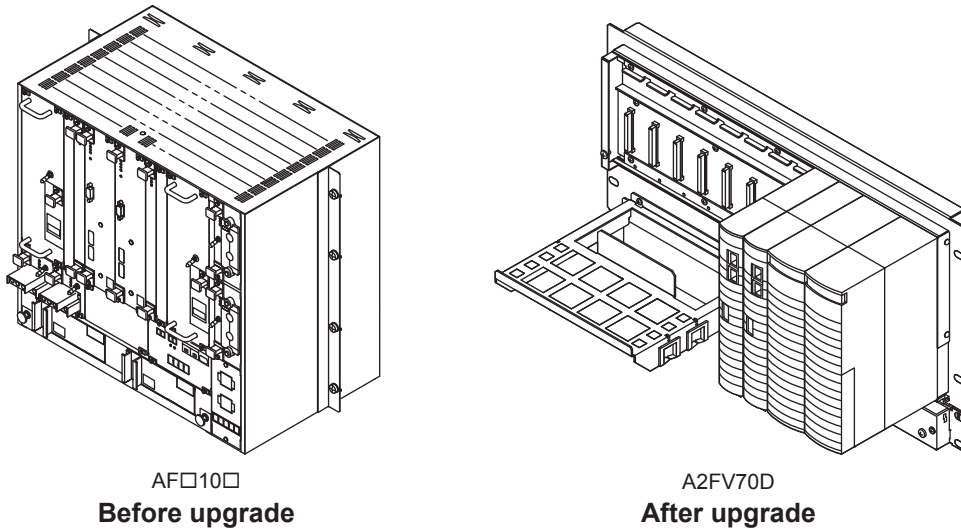

F040201.ai

Figure Upgrading rack mountable type FCU

● Upgrading cabinet type FCU

Existing FCU types		FCU types after upgrading	
Model	Description	Model	Description
AFE20S	Field control unit (with cabinet, for V net/RIO)	A2FV70S /HKU  +  A2CUKT3 -C□□□	Field control unit (for RIO System Upgrade, 19-inch rack mountable) (with HKU interface)  and  Cabinet Utility Kit (for RIO System Upgrade) (for FCU with cabinet (for A2FV70□/HKU))
AFM20S	Field control unit (with cabinet, for V net/RIO)		
AFH20S	Field control unit (with cabinet, capacity expanded type, for V net/RIO)		
AFS20S	Field control unit (with cabinet, capacity enhanced type, for V net/RIO)		
AFG20S	Field control unit (for RIO, with cabinet)		
AFE20D	Duplexed field control unit (with cabinet, for V net/RIO)	A2FV70D /HKU  +  A2CUKT3 -C□□□	Duplexed field control unit (for RIO System Upgrade, 19-inch rack mountable) (with HKU interface)  and  Cabinet Utility Kit (for RIO System Upgrade) (for FCU with cabinet (for A2FV70□/HKU))
AFM20D	Duplexed field control unit (with cabinet, for V net/RIO)		
AFH20D	Duplexed field control unit (with cabinet, capacity expanded type, for V net/RIO)		
AFS20D	Duplexed field control unit (with cabinet, capacity enhanced type, for V net/RIO)		
AFG20D	Duplexed field control unit (for RIO, with cabinet)		

Note: HKU stands for house keeping unit.

● Upgrade items

The figure below shows an image how the existing FCU with cabinet is upgraded into A2FV70□/ HKU Cabinet for RIO System Upgrade and A2CUKT3-C□□□ cabinet utility kit. The cabinet utility kit includes a fan unit, a housekeeping unit, and other components indispensable for RIO System Upgrade.

**SEE ALSO** For the details of the A2CUKT3-C□□□ cabinet utility kit, refer to Section 4.2.6 “Upgrading cabinets” and the General Specifications of “Field control unit, cabinet utility kit (for RIO System Upgrade)” (GS 33J64E10-01EN).

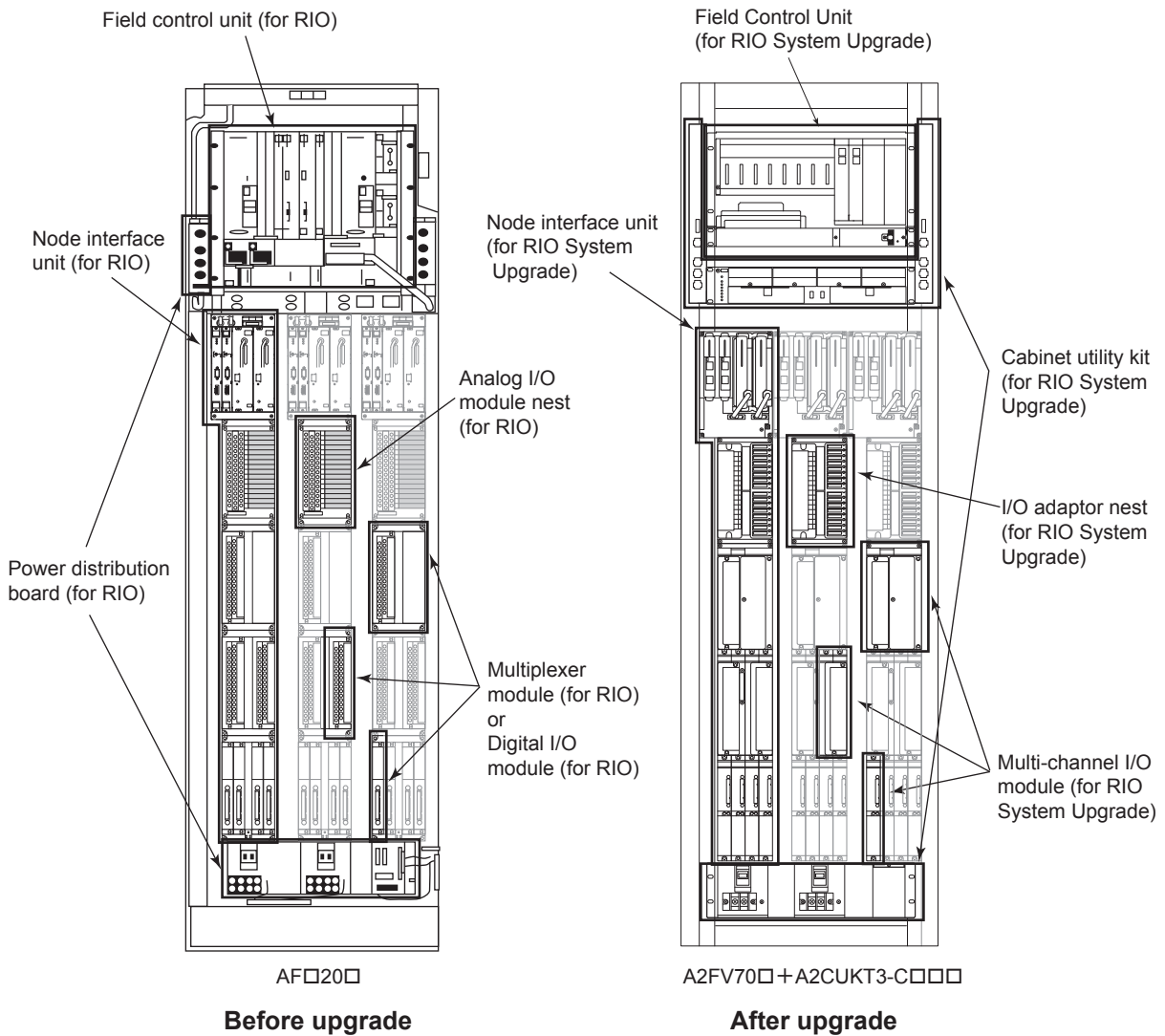

Figure Upgrading FCU with cabinet

F040202.ai

## 4.2.2 Upgrading PFC□

### ● Upgrading PFC□ control station

Existing model & description		Upgraded model & description	
PFC□	Control station	A2FV70S + A2NN10D □□5□□□□□□□□	Field control unit (for RIO System Upgrade, 19-inch rack mountable)  Node interface unit (for RIO System Upgrade, 19-inch rack mountable) (5 I/O units type)
PFCD	Duplexed control station	A2FV70D + A2NN10D □□5□□□□□□□□	Duplexed field control unit (for RIO System Upgrade, 19-inch rack mountable)  Node interface unit (for RIO System Upgrade, 19-inch rack mountable) (5 I/O units type)

### ● Upgrade items

The figure below shows an image how the existing PFC□ control station is upgraded by using the A2FV70□ field control unit and the A2NN10D node interface unit, and the installation space expands vertically.

**SEE ALSO**

For the details of the A2FV70□ field control unit, refer to the followings GS:

- Field control unit, cabinet utility kit (for RIO System Upgrade) (GS 33J64E10-01EN)
- N-IO node (for RIO System Upgrade) (GS 33J64F10-01EN)

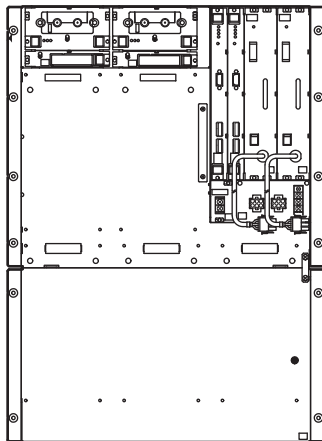

PFC□

Before upgrade

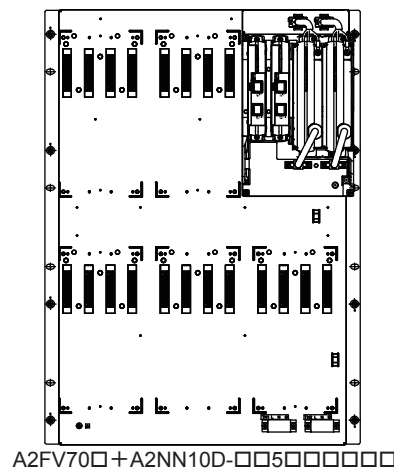
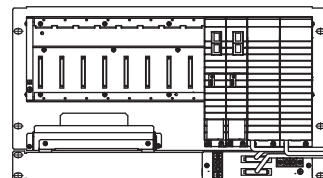

A2FV70□ + A2NN10D-□□5□□□□□□□□

After upgrade

F040203.ai

Figure Upgrading PFC□ Control Station

## 4.2.3 Upgrading I/O expansion cabinet

- Upgrading I/O expansion cabinet

Existing model & description		Upgraded model & description	
ACB21	I/O Expansion Cabinet	A2CUKT3-N□□□	Cabinet Utility Kit (for RIO System Upgrade) (for I/O Expansion Cabinet (for ACB21))

### Upgrade items

The figure below shows an image how the existing I/O expansion cabinet is upgraded into A2CUKT3-N□□□ cabinet utility kit. The cabinet utility kit includes a fan unit, a housekeeping unit interface, and other components indispensable for RIO System Upgrade.

**SEE ALSO**

For the details of the A2CUKT3-N□□□ cabinet utility kit, refer to Section 4.2.6 “Upgrading cabinets” and the General Specifications of “Field control unit, cabinet utility kit (for RIO System Upgrade)” (GS 33J64E10-01EN).

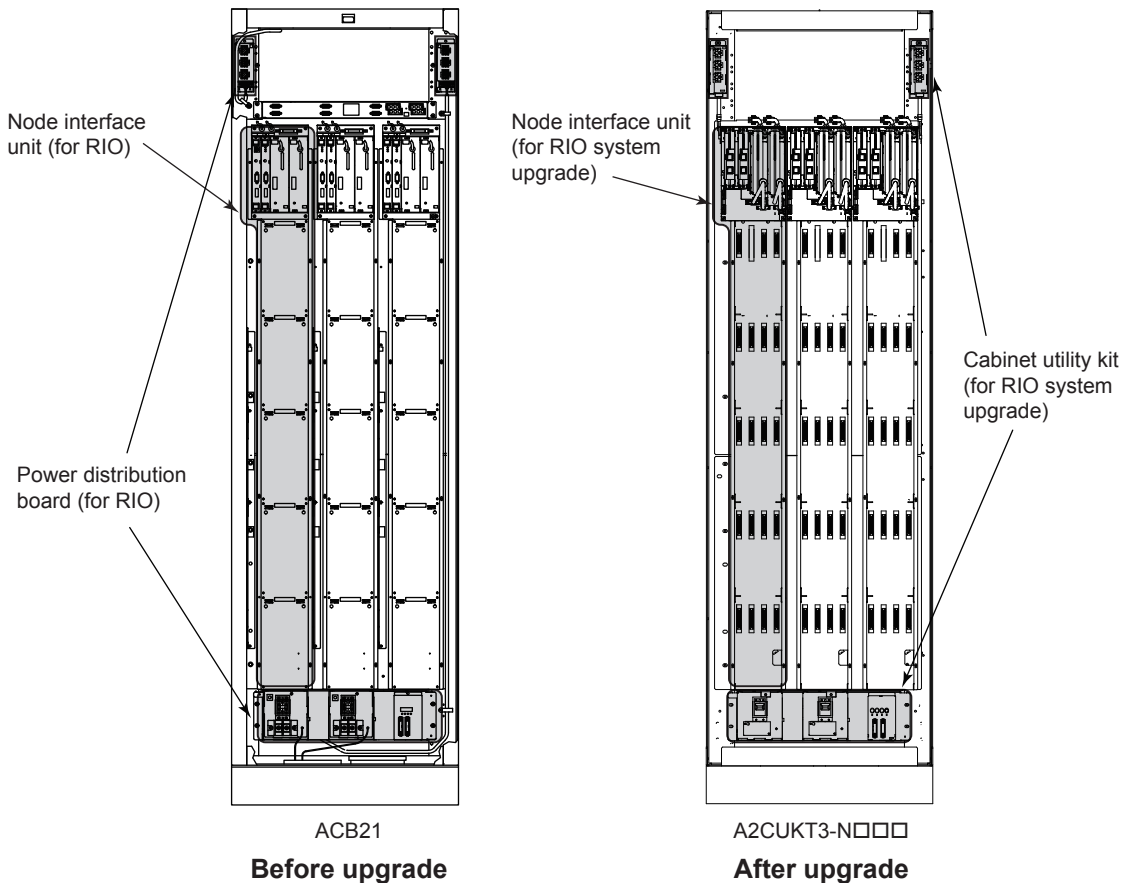

Figure Upgrading I/O expansion cabinet

F040204.ai



## 4.2.4 Upgrading node interface unit

### ● Upgrading node interface unit (rack mountable type)

Existing model & description		Upgraded model & description	
ANS10	Node interface unit for single RIO bus (19-inch rack mountable type)	A2NN10D	Node interface unit (for RIO System Upgrade, 19-inch rack mountable) (2 I/O units type)
AND10	Node interface unit for redundant RIO bus (19-inch rack mountable type)	-□□2□□□□□□□□	
ANS50	Node interface unit for single RIO bus (19-inch rack mountable type)	A2NN10D	Node interface unit (for RIO System Upgrade, 19-inch rack mountable) (5 I/O units type)
AND50	Node interface unit for redundant RIO bus (19-inch rack mountable type)	-□□5□□□□□□□□	

Note: ARK11 I/O expansion rack is designed to use in combination with AN□, and upgraded by using A2NN10D-□□5□□□□□□□□ which is regarded as equivalent to AN□.

Note: ANS11 and AND11 communication expansion node are substituted by ANB10D and ANB11D, and its communication module is upgraded with a communication module for FIO.

### Upgrade items

The figure below shows an image how the existing node interface unit (rack mountable type) is upgraded into the node interface unit for RIO System Upgrade which has the same shape. Construction work for dropping commercial power supply and I/O bus is required as the same as the existing system.

**SEE ALSO**

For the A2NN10D node interface after upgrading, refer to the GS for “N-IO node (for RIO System Upgrade)” (GS 33J64F10-01EN).



F040205.ai

**Figure Upgrading node interface unit (rack mountable type)**

● Upgrading node interface unit (cabinet type)

Existing model & description		Upgraded model & description	
ANS20	Node interface unit for single RIO bus (Cabinet type)	A2NN20D	Node interface unit (for RIO System Upgrade, cabinet installation type)
AND20	Node interface unit for redundant RIO bus (Cabinet type)		

**Upgrade items**

The figure below shows an image how the existing node interface unit (cabinet type) is upgraded into the node interface unit for RIO System Upgrade which has the same shape. For upgrading the existing field control stations, two different sizes of the node interface units are provided; one is with four I/O units to upgrade the front and the other with five I/O units to upgrade the rear.

**SEE ALSO**

For the details of the A2NN20D node interface unit, refer to the GS “N-IO node (for RIO System Upgrade)” (GS 33J64F10-01EN).

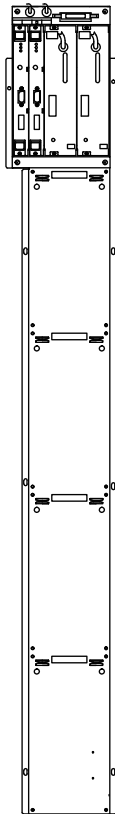

AN□20-F□□

**Before upgrade**

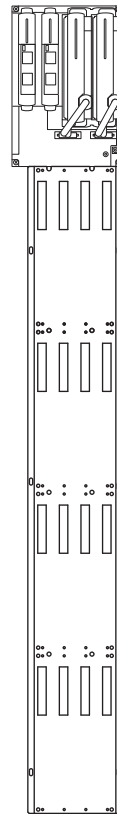

A2NN20D-□□4□□□□□□

**After upgrade**

**Figure Upgrading node interface unit (cabinet type)**

F040206.ai

## 4.2.5 Upgrading overall I/O

### 4.2.5.1 Upgrading RIO System components

- Upgrading I/O module nest

Existing Model			Upgraded Model		
Model	Description	Q'ty (*1)	Model	Description	Q'ty (*1)
AMN11	Nest for analog I/O modules	1	A2BA3D	Nest for I/O adaptor (for RIO System Upgrade, with I/O module)	1
AMN12	High-speed nest for analog I/O modules				
AMN21	Nest for relay I/O modules	1	Multi-channel I/O modules for upgrading are directly mounted to the backboard of the node interface unit. Communication modules are upgraded into communication module for FIO system and mounted to the A2FV70□ FCU or ANB10D/ANB11D node unit.		
AMN31	Nest for terminal-type I/O modules				
AMN32	Nest for connector-type I/O modules				
AMN33	Nest for communication modules				
AMN34	Nest for multipoint control analog I/O modules	1			
AMN51	Nest for communication cards and Ethernet communication modules	1			

\*1: Maximum number of units mountable per I/O unit area.

### Upgrade items

The figure below shows an image how the existing I/O module nest is upgraded. The existing channel-based AMN11 or AMN12 nests for analog I/O modules are upgraded by A2BA3D I/O adaptor nest which has the same shape. For upgrading, the field wiring has to be removed and then connected with the M4 screw terminal (detachable) again. The position (XYZ coordinates) of the A2BA3D terminal base is almost the same as the existing AMN11 or AMN12 and the existing field wiring can be continually used.

**SEE ALSO**

For the details of the A2BA3D I/O adaptor nest after upgrading, refer to the GS of "N-IO node (for RIO System Upgrade)" (GS 33J64F10-01EN).

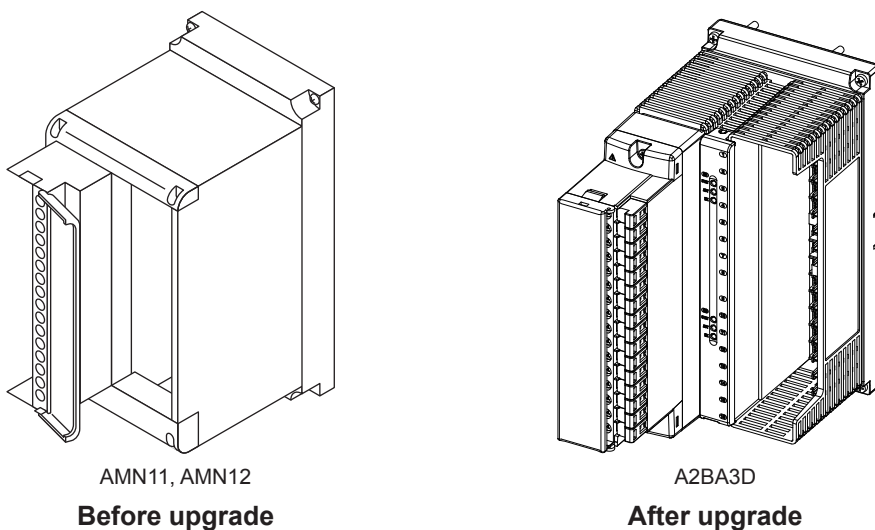

F040207.ai

**Figure** Upgrading I/O module nest

● Upgrading I/O module by the channel

Existing I/O module			Upgraded I/O module		
Model	Description	Q'ty (*1)	Model	Description	Q'ty (*1)
AAM10	Current/voltage input module (simplified type)	16	A2SAM105	Current input/voltage input adaptor	16
AAM11	Current/voltage input module				
AAM11B	Current/voltage input module (supports BRAIN)				
AAM21	mV, thermocouple, and RTD input module		A2SAT105	mV/TC/RTD Input adaptor	
AAM21J	mV, thermocouple, and RTD input module (conforms to IEC584-1995, IEC751-1995)				
APM11	Pulse input module		A2SAP105	Pulse input signal adaptor (0 -10 KHz)	
AAM50	Current output module		A2SAM505	Current output/voltage output adaptor	
AAM51	Current/voltage output module				

\*1: Maximum number of units mountable per nest.

**Upgrade items**

The figure below shows an image how the existing I/O module is upgraded by the channel. Connection specifications of field wiring (wiring connection types of A, B, and C terminals assigned by the type of signals) are the same before and after upgrading. The A2SAM505 output adaptor for current/voltage output modules can be configured in dual redundant in the same way as AAM51. The short bar used for M4 screw terminal used for dual-redundant configuration, the same product as the existing system can be used.

**SEE ALSO**

For the details of the I/O adaptor after upgrading, refer to the GS of "N-IO node (for RIO System Upgrade)" (GS 33J64F10-01EN).

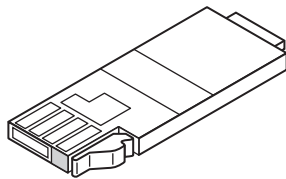

AAM10, AAM11, AAM11B, AAM21, AAM21J, APM11, AAM50, and AAM51

**Before upgrade**

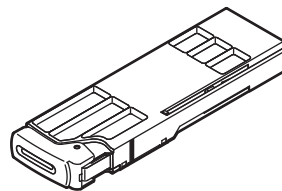

A2SAM105, A2SAT105, A2SAP105, and A2SAM505

**After upgrade**

F040208.ai

**Figure Upgrading channel I/O module**